

## Vacuum filters

**FESTO**





# Vacuum filters ESF

## Technical data

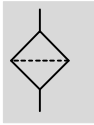
### Function



-  Temperature range  
0 ... +60 °C
-  Operating pressure  
-0.95 ... +4 bar

Accessory for the suction gripper ESG, mounted between suction cup holder and suction cup with connection attachments

→ Internet: esg



General technical data			
Classification of suction cup holders	Size 3	Size 4	
		For suction cup Ø 20 mm	For suction cup Ø 30/40/50 mm
Pneumatic connection	M4	M6	
Vacuum port	M4	M6	
Mounting position	Any		
Type of mounting	With male thread via vacuum port		
Grade of filtration [µm]	10		
Flow rate <sup>1)</sup> [l/min]	100	260	270

1) At partial vacuum = -0.75 bar

Operating and environmental conditions	
Operating pressure [bar]	-0.95 ... +4
Operating medium	Atmospheric air based on ISO 8573-1:2010 [7:-:-]
Ambient temperature [°C]	0 ... +60
Corrosion resistance class CRC <sup>1)</sup>	1

1) Corrosion resistance class CRC 1 to Festo standard FN 940070  
Low corrosion stress. For dry indoor applications or transport and storage protection. Also applies to parts behind covers, in the non-visible interior area, and parts which are covered in the application (e.g. drive trunnions).

Materials	
Housing	Aluminium, nickel-plated brass
Filters	PVF
Seals	NBR
Note on materials	RoHS-compliant Free of copper and PTFE

### Dimensions Download CAD data → [www.festo.com](http://www.festo.com)

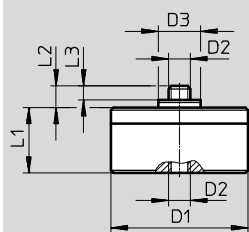

Ordering data									
Classification of suction cup holders	D1 Ø	D2	D3 Ø	L1	L2	L3	Weight [g]	Part No.	Type
Size 3	25	M4	7.8	10.5	4.5	3	9	191202	ESF-3
Size 4	25	M6	8.8	10.5	5.5	4	19	191203	ESF-4A
	40	M6	8.8	14	5.5	4	19	191204	ESF-4B

# Vacuum filters VAF-PK

Technical data

## Function

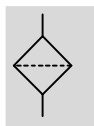

- - Temperature range  
0 ... +40 °C
- - Operating pressure  
-0.95 ... 0 bar



## Note

Only for use in open vacuum systems.

The vacuum filter is used to filter particles in the direction of suction. The vacuum filter is inserted as an in-line filter in the tubing line. On initial

installation any flow direction can be chosen. After disassembly and installation of the vacuum filter the original

flow direction must be kept. The fabric filter element is located in a transparent housing so that the de-

gree of contamination of the filter cartridge can be identified. It is not possible to replace the filter.

General technical data			
Pneumatic connection	PK-3 with union nut	PK-4 with union nut	PK-6 with union nut
Nominal width [mm]	2	3	4.6
Mounting position	Any		
Type of mounting	In-line installation		
Grade of filtration [µm]	50		
Flow rate <sup>1)</sup> [l/min.]	50.8	70	210
Ejector pulse suitability [bar]	≤8		

1) At partial vacuum = -0.75 bar

Operating and environmental conditions	
Operating pressure [bar]	-0.95 ... 0
Note on operating pressure	Only for use in open vacuum systems
Operating medium	Compressed air to ISO 8573-1:2010 [7:-:-]
Ambient temperature [°C]	0 ... +40

Materials	
Housing	PA
Filters	Fabric, PA
Union nut	POM
Note on materials	RoHS-compliant

## Dimensions

Download CAD data → [www.festo.com](http://www.festo.com)

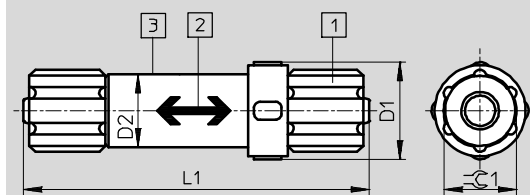

- 1 Quick connector for plastic tubing
- 2 Flow direction indicated with arrow
- 3 Degree of contamination visible through the transparent housing

Ordering data						
Connection	D1 ∅	D2 ∅	L1	±0.1	Weight [g]	Part No. Type
PK-3	16	12	50.8	8	4	535883 VAF-PK-3
PK-4	16	12	57	12	6	15889 VAF-PK-4
PK-6	24	19	64	14	10	160239 VAF-PK-6



# Vacuum filters VAF-DB

Technical data

FESTO

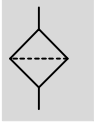
Function



-  - Temperature range  
-5 ... +50 °C
-  - Operating pressure  
-0.95 ... 0 bar



-  - Note  
Only for use in open vacuum systems.

The vacuum filter is used to filter particles in the direction of suction. The filter cartridge is located in a transparent bowl so that the degree of

contamination of the filter cartridge can be identified. The filter cartridge can be replaced → 6.

General technical data			
Pneumatic connection	G1/4	G3/8	G1/2
Vacuum port	G1/4	G3/8	G1/2
Mounting position	Vertical		
Type of mounting	In-line installation Via wall/surface bracket → 6		
Grade of filtration [µm]	80		
Ejector pulse suitability [bar]	≤7		
Max. tightening torque [Nm]	8.7	15.3	20.5

Operating and environmental conditions	
Operating pressure [bar]	-0.95 ... 0
Note on operating pressure	Only for use in open vacuum systems
Operating medium	Compressed air to ISO 8573-1:2010 [7:-:-]
Ambient temperature [°C]	-5 ... +50

Materials	
Housing	PP reinforced
Bowl	PA
Filters	PE
Seals	Nitrile rubber
Note on materials	RoHS-compliant Contains PWIS (paint-wetting impairment substances)

# Vacuum filters VAF-DB

Technical data

FESTO

## Standard flow rate $q_n$ as a function of differential pressure $\Delta p_{1-2}$

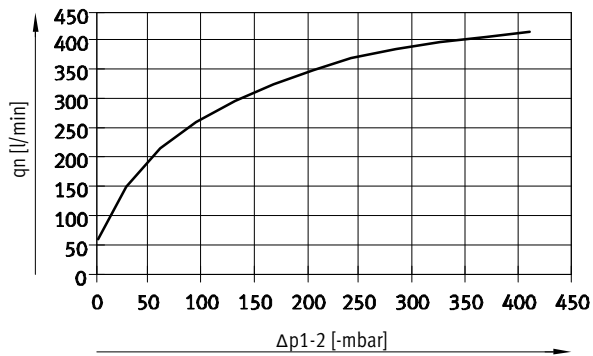

— VAF-DB-1/4

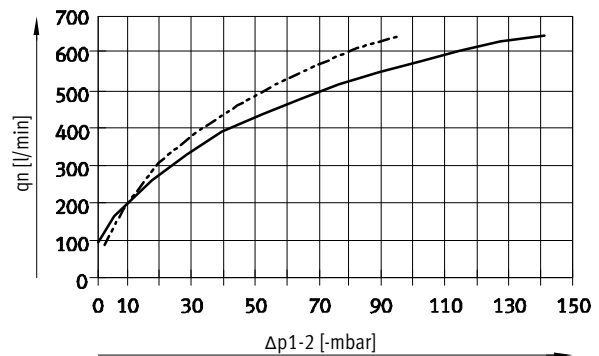

— VAF-DB-3/8  
 - - - VAF-DB-1/2

## Dimensions

Download CAD data → [www.festo.com](http://www.festo.com)

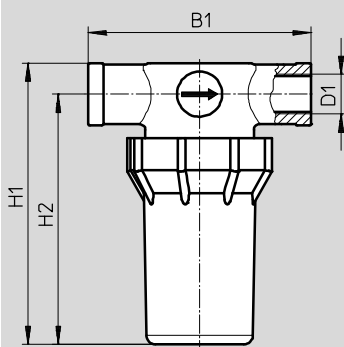

## Ordering data

Connection	B1	H1	H2	Weight [g]	Part No.	Type
D1						
1/4	75	94.5	84.5	71	547261	VAF-DB-1/4
3/8	90.5	125	113	156	553140	VAF-DB-3/8
1/2	90.5	129	115	162	553141	VAF-DB-1/2

# Vacuum filters VAF-DB

Accessories

## Mounting bracket VAF-DB-HR for vacuum filter VAF-DB

Type of mounting: threaded  
Max. tightening torque: 0.63 Nm

Materials:  
High-alloy stainless steel

Note on materials:  
RoHS-compliant  
Contains PWIS (paint-wetting  
impairment substances)

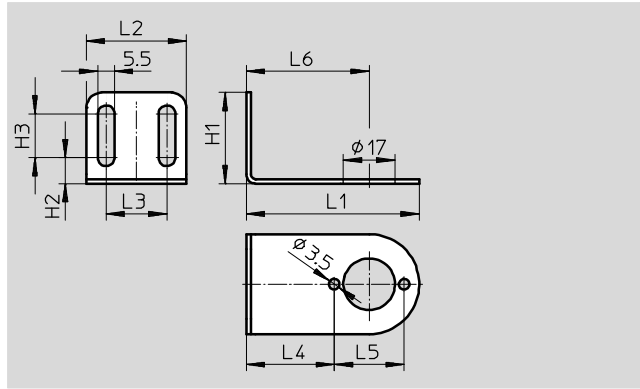

Dimensions and ordering data												
L1	L2	L3	L4	L5	L6	H1	H2	H3	CRC <sup>1)</sup>	Weight [g]	Part No.	Type
57	33	20	29	23	40.5	30	8.5	14.5	2	27	553144	VAF-DB-HR-1/8-1/4
80	53	35	37	33	53.5	50	13.5	24.5	2	92	553145	VAF-DB-HR-3/8-1/2

1) Corrosion resistance class CRC 2 to Festo standard FN 940070  
Moderate corrosion stress. Indoor applications in which condensation may occur. External visible parts with primarily decorative requirements for the surface and which are in direct contact with the ambient atmosphere typical for industrial applications.

## Filter cartridge VAF-DB-P for vacuum filter VAF-DB

Type of mounting: plug-in

Material: PE

Note on materials:  
RoHS-compliant  
Contains PWIS (paint-wetting  
impairment substances)



Ordering data		
	Part No.	Type
For vacuum filters VAF-DB	553142	VAF-DB-P-1/8-1/4
	553143	VAF-DB-P-3/8-1/2